

1 2 3 4 5 6 7 8

A
B
C
D
E
F

A
B
C
D
E
F

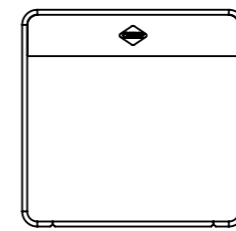
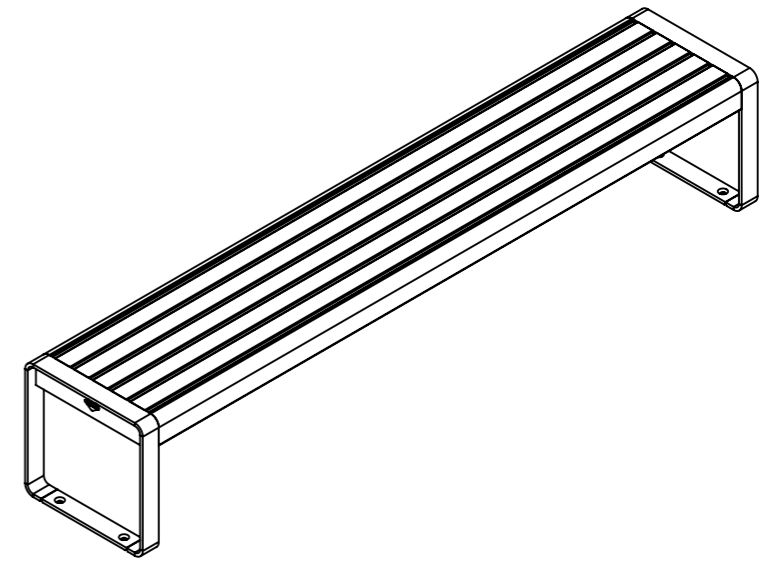
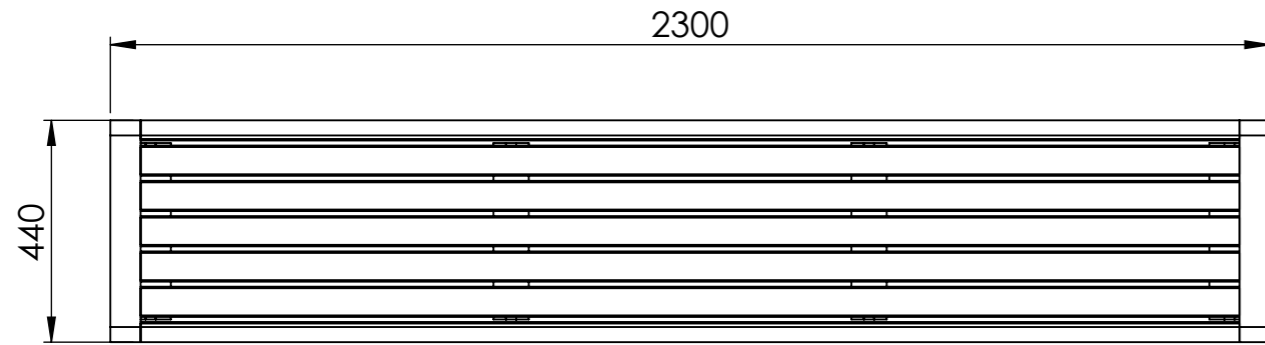

DRAWN	Pleuni Bongers	DATE	25-2-2021		TITLE:			
REVISION					STBE.2300			
				Liessentstraat 4, 5405 AG Uden (NL). † 0031 (0)413 - 27 41 68. e info@furns.nl, i www.furns.nl		Drawing.	STBE.2300	A3
Color:	-	Mass(kg):	53.14	SCALE:	1:15	SHEET 1 OF 4		

1 2 3 4