

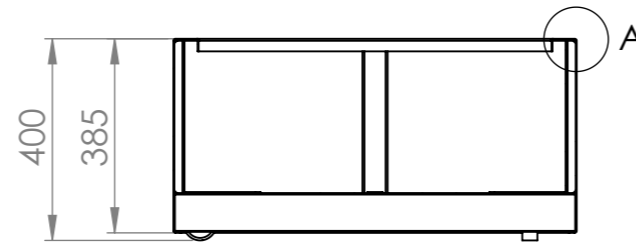

DETAIL A  
SCALE 1 : 2

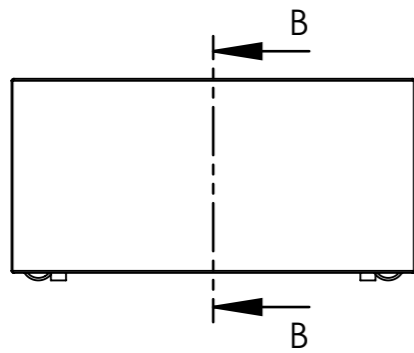

SECTION B-B

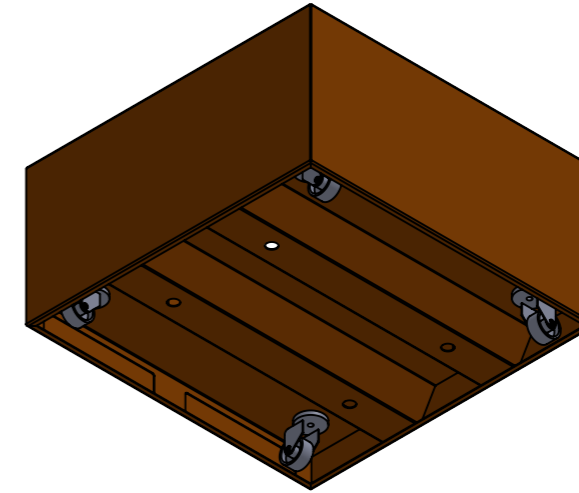
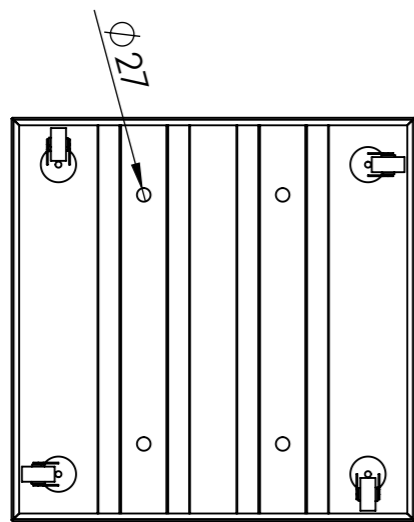
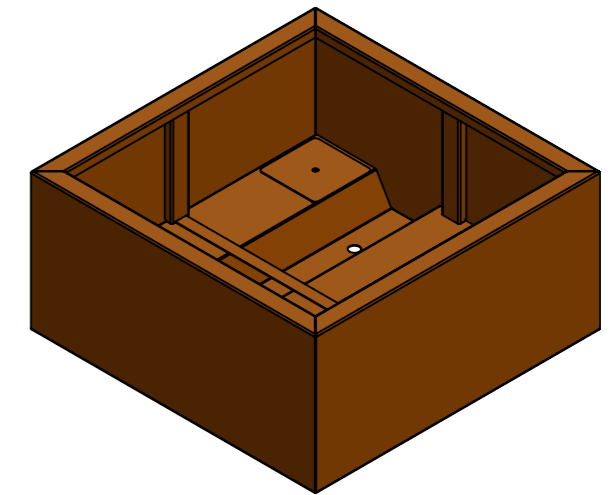

DRAWN	Benny Dijkhuis	DATE	8-11-2019		TITLE:		
REVISION	Luuk van der Heuvel	DATE	9-12-2020		2mm Corten		
				Liessentstraat 4, 5405 AG Uden (NL). † 0031 (0)413 - 27 41 68. e info@adezz.com, i www.adezz.com		Drawing:	A3
Color:		Mass (kg):	<b>39.35</b>	SCALE:1:15	CAWL 6.3	SHEET 1 OF 7	